



D0287A001-00  
UK  
Version 0

EN



Video setup instructions:  
[support.brother.com/videos](http://support.brother.com/videos)



The latest manuals are available at the Brother support website:  
[support.brother.com/manuals](http://support.brother.com/manuals)

## Unpack the machine and check the components

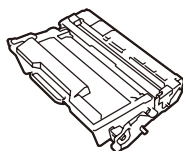
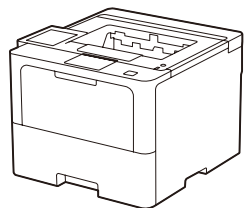

**Toner Cartridge and Drum Unit Assembly**  
(Installed in the machine)



**AC Power Cord**



**USB Port Cover**  
(Not included in all models)



**Quick Setup Guide**



**Product Safety Guide**

**NOTE:**

- The components included in the box may differ depending on your country.
- The available connection interfaces vary depending on the model. You must purchase the correct interface cable if you require one.
  - **USB cable**  
We recommend using a USB 2.0 cable (Type A/B) that is no more than 2 metres long.
  - **Network cable**  
Use a straight-through Category 5 (or greater) twisted-pair cable.
- The illustrations in this *Quick Setup Guide* show the HL-L6415DN.
- Brother aims to reduce waste and save both raw materials and the energy required to produce them.  
Read more about our environmental work at [www.brotherearth.com](http://www.brotherearth.com).

### 1 Remove the packing materials and re-install the toner cartridge and drum unit assembly

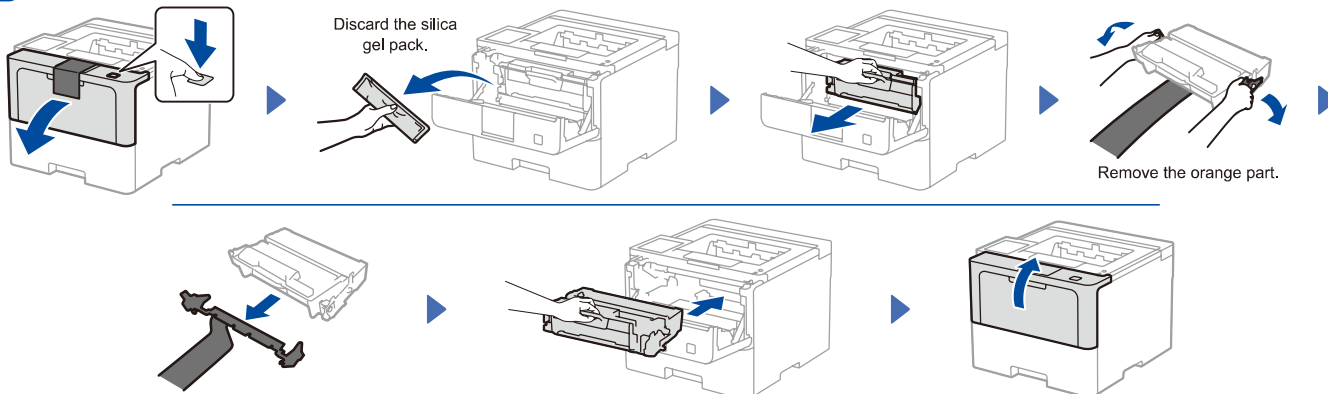

### 2 Load paper in the paper tray

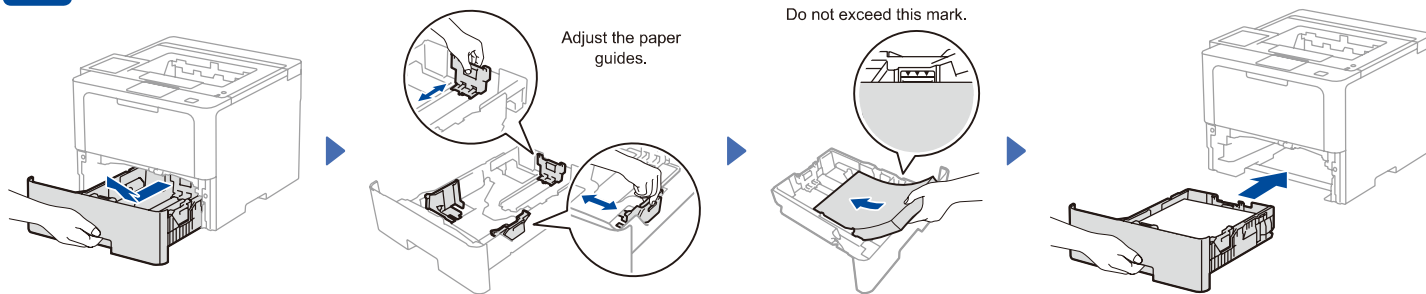

### 3 Connect the power cord and turn the machine on

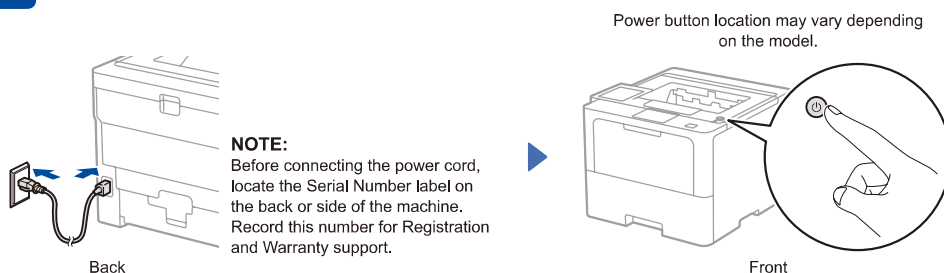

**NOTE:**  
Before connecting the power cord, locate the Serial Number label on the back or side of the machine. Record this number for Registration and Warranty support.

Power button location may vary depending on the model.



## 4 Select your language (if needed)

■ For LCD models

1. Press ▼ or ▲ to select [Initial Setup], and then press **OK**.
2. Press ▼ or ▲ to select [Local Language], and then press **OK**.
3. Press ▼ or ▲ to select your language, and then press **OK**.
4. Press **Cancel**.

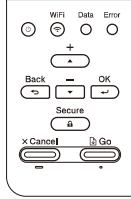

■ For touchscreen models

1. On the machine's touchscreen, press [Settings] > [All Settings] > [Initial Setup] > [Local Language].
2. Press your language.
3. Press



## 5 Connect your computer or mobile device to your machine

Follow these steps to complete the setup using one of the connection types available on your machine.

Visit [setup.brother.com](http://setup.brother.com) to download and install Brother software.

Follow the on-screen instructions and prompts.

### Setup Finished

You can now print using your machine.

To check for the latest firmware, visit [support.brother.com/up7](http://support.brother.com/up7).

#### Important Notice for Network Security:

The default password to manage this machine's settings is located on the back of the machine and marked "Pwrd". We recommend immediately changing the default password to protect your machine from unauthorised access.

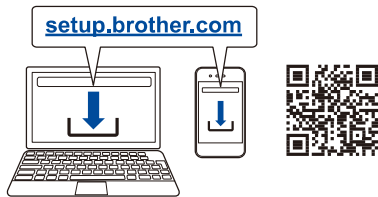

### Can't Connect? Check the following:

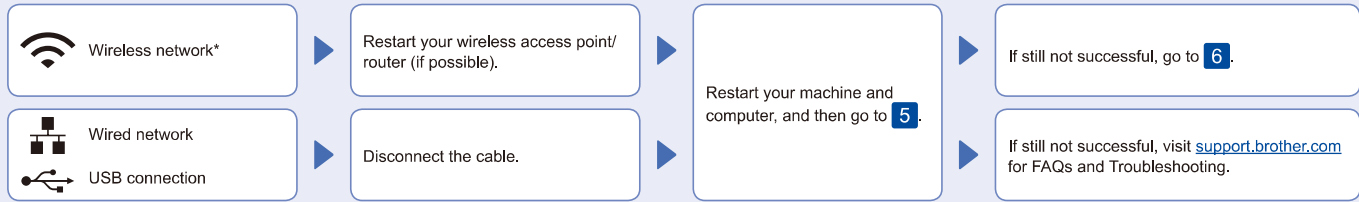

\* For certain models, the wireless network connection can be used only when the optional Wireless Module is installed.

## 6 Manual wireless setup (Wireless models)

If the wireless setup is not successful, try to set up the connection manually.

For certain models, the wireless network connection can be used only when the optional Wireless Module is installed.

Find your SSID (Network Name) and Network Key (Password) on your wireless access point/router and write them in the table provided below.

SSID (Network Name)	
Network Key (Password)	

■ For LCD models

To select menu options, press ▲ or ▼, and then press **OK** to confirm.  
 Select [Network] > [WLAN (Wi-Fi)] > [Find Network].  
 Follow the LCD instructions.

Select the SSID (Network Name) for your access point/router and enter the Network Key (Password).

■ For LCD models

Press and hold (or press repeatedly) ▲/▼ to select one of the following characters:  
 0123456789abcdefghijklmnopqrstuvwxyz  
 ABCDEFGHIJKLMNOPQRSTUVWXYZ  
 (space)!"#\$%&'()\*+,-./:;<=>?@[ \ ] ^ \_ { } ~

Go to **5** to install software.

■ For touchscreen models

Press > [Find Wi-Fi Network].  
 Follow the LCD instructions.

When the wireless setup is successful, the touchscreen/LCD displays [Connected].

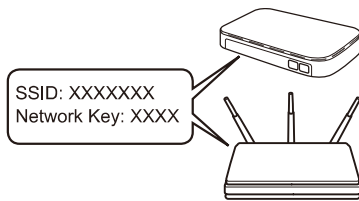

If you cannot find this information, ask your network administrator or wireless access point/router manufacturer.

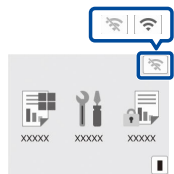

If setup is not successful, restart your Brother machine and your wireless access point/router, and repeat **6**.  
 If still not successful, visit [support.brother.com](http://support.brother.com).